



Mac Chain Co. Ltd.

800-663-0072
[UNITED STATES]

800-663-0072
[WESTERN CANADA]

877-833-1653
[EASTERN CANADA]

A2-WR150

ATTACHMENTS > Welded Steel Chain Attachments

Industry: AG Spreader, Grain Processing, Car Wash Conveyor, Forest Products

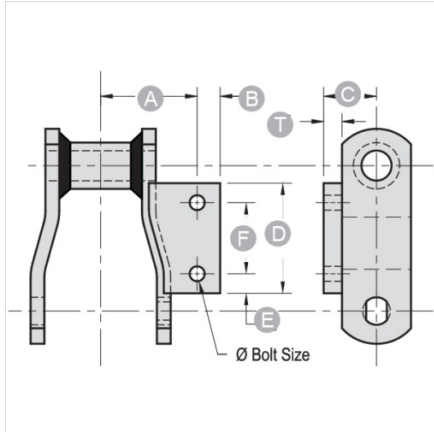

NOTE: All dimensions shown in inches unless noted otherwise.

Part Number	Ø Bolt Size	A	B	C	D	E
A2-WR150	1/2	3.75	13/16	1 3/4	4	1.625

Part Number	F	T
A2-WR150	2.75	1/2

Questions about ordering? Call us!

WE'RE HERE TO HELP!
www.macchain.com
ussales@macchain.com

