



Mac Chain Co. Ltd.

800-663-0072
[UNITED STATES]

800-663-0072
[WESTERN CANADA]

877-833-1653
[EASTERN CANADA]

WD104-9

DRAG CHAIN SPROCKETS > WD104 Sprocket

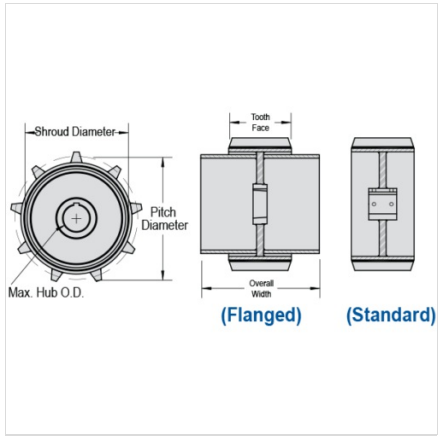

Part Number	Average Pitch	Number of Teeth	Pin Style	Pitch Diameter	Max. Bore	Shroud Diameter
WD104-9	6.000	9	Flanged & Standard	17.54	5 15/16	14.99
Part Number				Tooth Face		
WD104-9				4 1/8		

Questions about ordering? Call us!

WE'RE HERE TO HELP!
www.macchain.com
ussales@macchain.com

