



Mac Chain Co. Ltd.

800-663-0072
[UNITED STATES]

800-663-0072
[WESTERN CANADA]

877-833-1653
[EASTERN CANADA]

WD112-7

DRAG CHAIN SPROCKETS > WD112 Sprocket

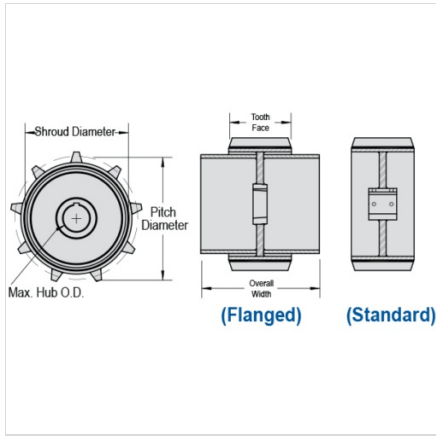

Part Number	Average Pitch	Number of Teeth	Pin Style	Pitch Diameter	Max. Bore	Shroud Diameter
WD112-7	8.000	7	Flanged & Standard	18.44	5 15/16	15.114
Part Number				Tooth Face		
WD112-7				9		

Questions about ordering? Call us!

WE'RE HERE TO HELP!
www.macchain.com
ussales@macchain.com

