



Mac Chain Co. Ltd.

800-663-0072
[UNITED STATES]

800-663-0072
[WESTERN CANADA]

877-833-1653
[EASTERN CANADA]

WD122-9

DRAG CHAIN SPROCKETS > WD122 Sprocket

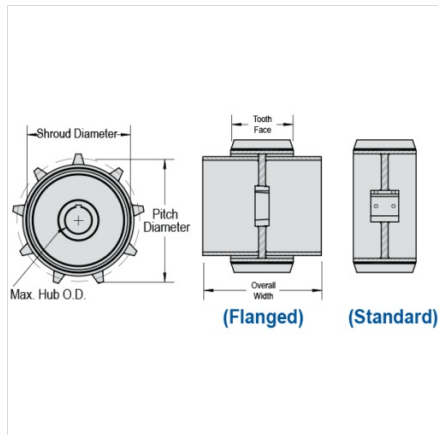

Part Number	Average Pitch	Number of Teeth	Pin Style	Pitch Diameter	Max. Bore	Shroud Diameter
WD122-9	8.000	9	Flanged & Standard	23.39	5 15/16	19.98
Part Number	Tooth Face					
WD122-9	8 3/4					

Questions about ordering? Call us!

WE'RE HERE TO HELP!
www.macchain.com
ussales@macchain.com

