



Mac Chain Co. Ltd.

800-663-0072  
[UNITED STATES]

800-663-0072  
[WESTERN CANADA]

877-833-1653  
[EASTERN CANADA]

## WR82XHDPIN

WELDED STEEL PIN > Mill Chain H & C Type Pin

**Industry:** AG Spreader, Grain Processing, Asphalt Paving, Sanding Truck Conveyor, Car Wash Conveyor, Mobile Wood Waste Recycling, Forest Products

- Pins can be supplied "pre-drilled" for cotter pins
- Dimensions in brackets apply to optional 1" A Rivets
- Most rivets chamfered on end for "lead in"
- Custom sizes are also available

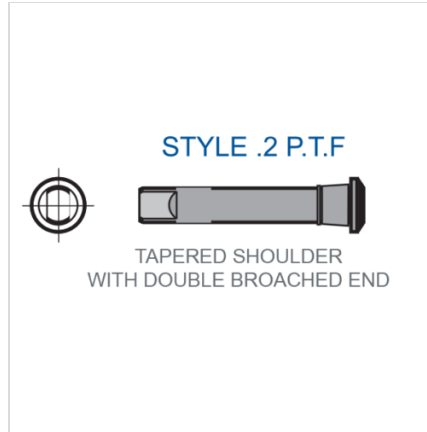
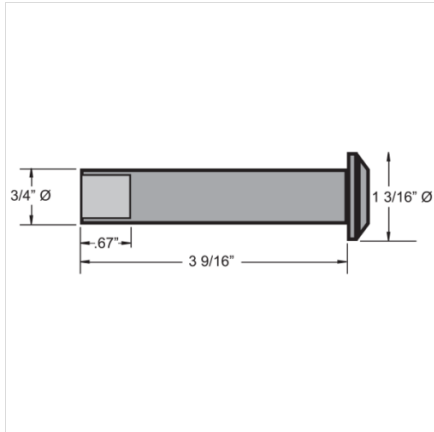

Part Number	Pin Style	Pin Size	Weight Per 100 pcs.
WR82XHDPIN	2	3/4 x 3 9/16	51

Questions about ordering? Call us!

WE'RE HERE TO HELP!

[www.macchain.com](http://www.macchain.com)  
[ussales@macchain.com](mailto:ussales@macchain.com)

